

جایزه نوبل سال ۲۰۲۲

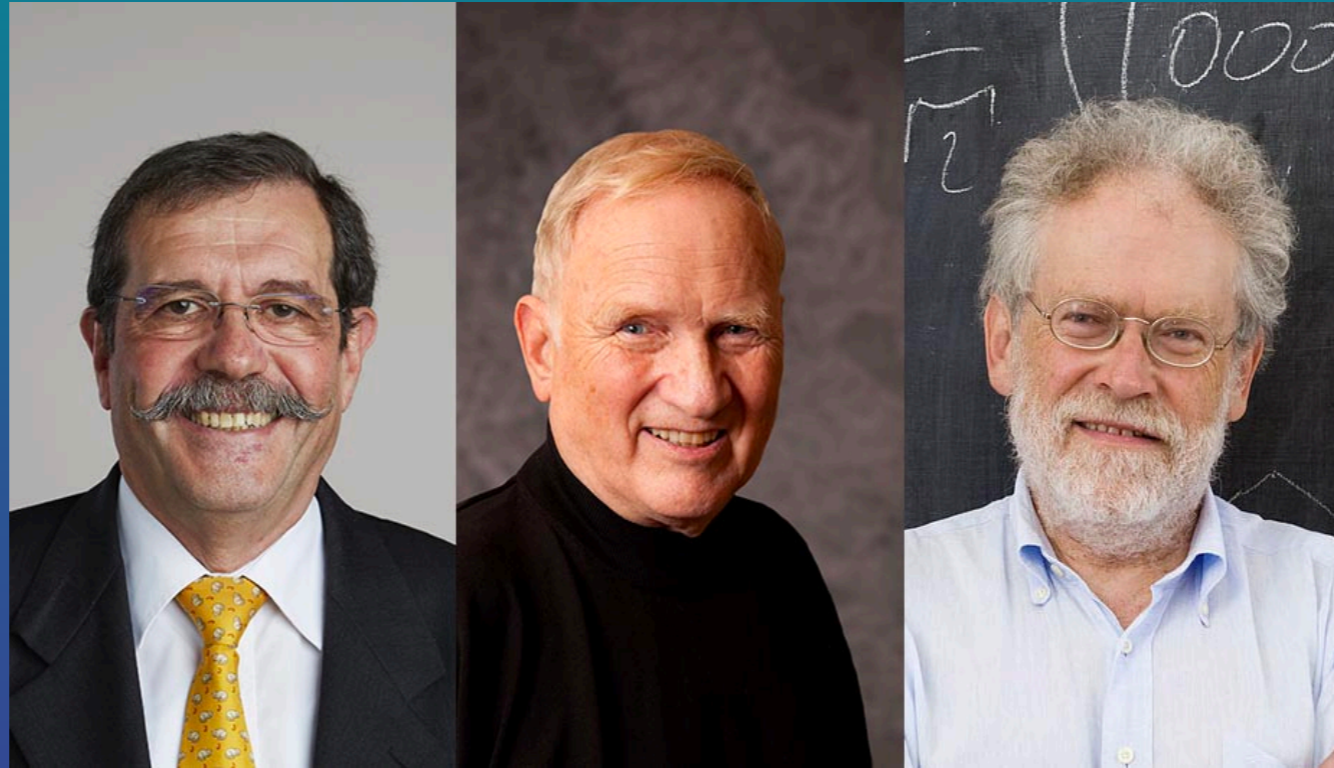

Alain Aspect John Clauser Anton Zeilinger

دانشگاه شهید بهشتی، آذرماه ۱۴۰۱

وحید کریمی پور،

دانشکده فیزیک، دانشگاه صنعتی شریف



If you think you understand
quantum mechanics, you don't
understand quantum mechanics.

— *Richard P. Feynman* —

AZ QUOTES

HIDDEN VARIABLES

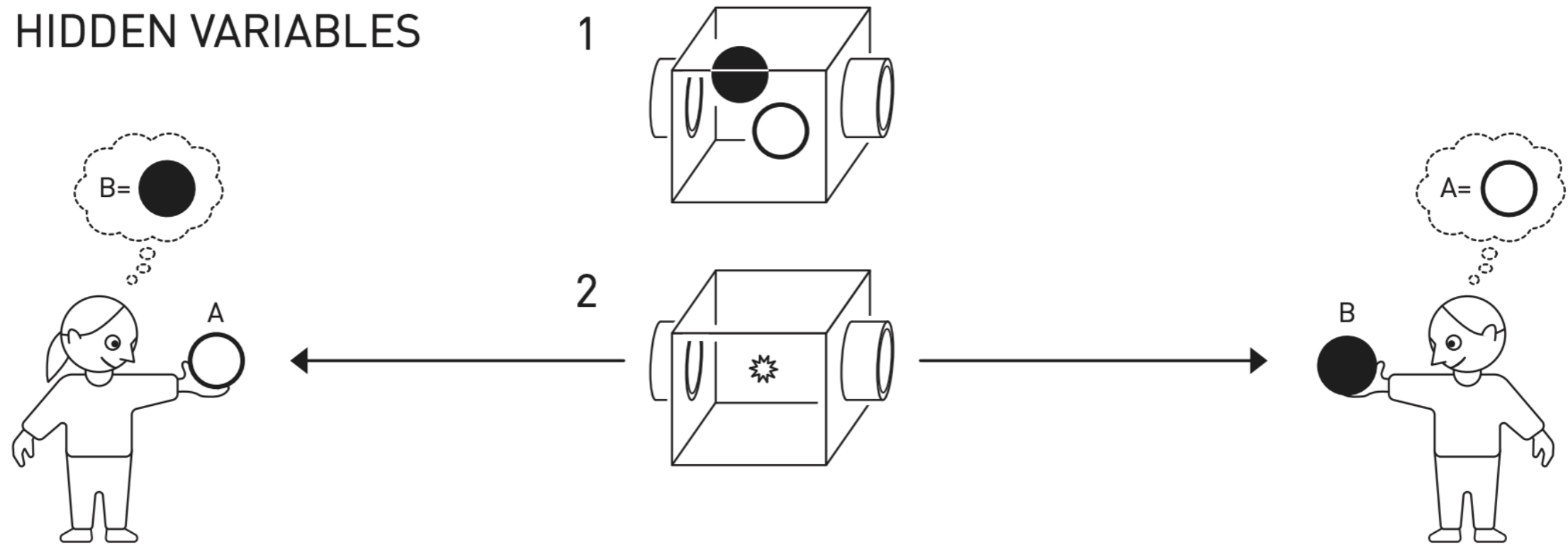

QUANTUM MECHANICS

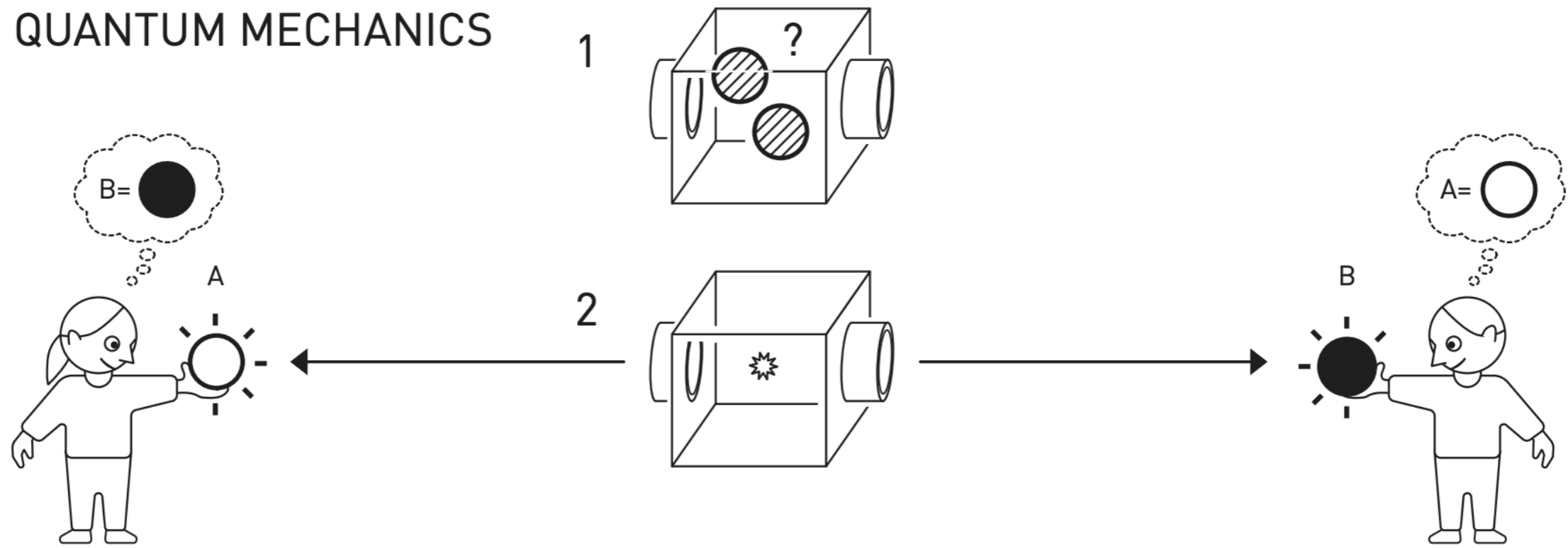

Entangled particles that never met

Two pairs of entangled particles are emitted from different sources. One particle from each pair is brought together in a special way that entangles them. The two other particles (1 and 4 in the diagram) are then also entangled. In this way, two particles that have never been in contact can become entangled.

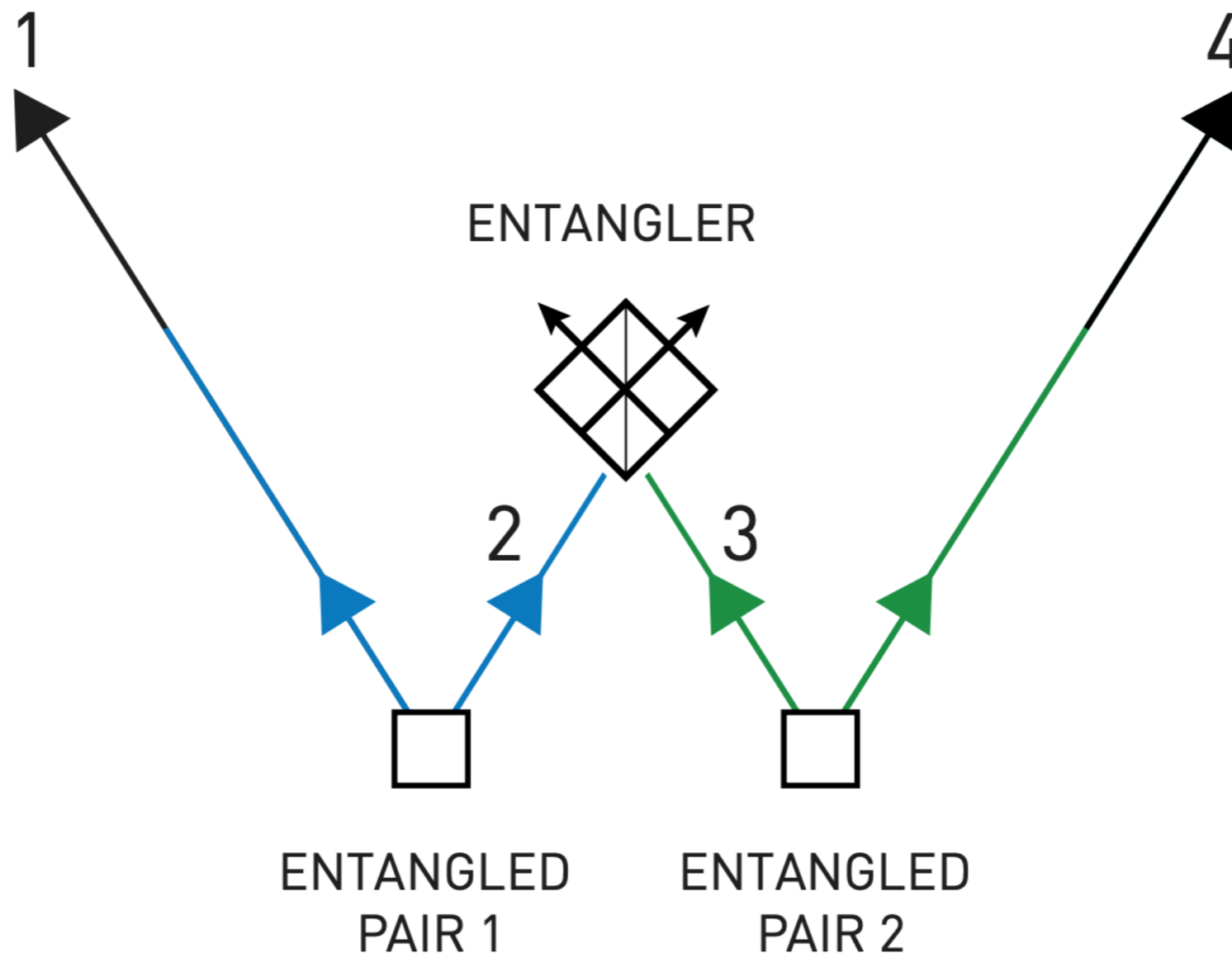

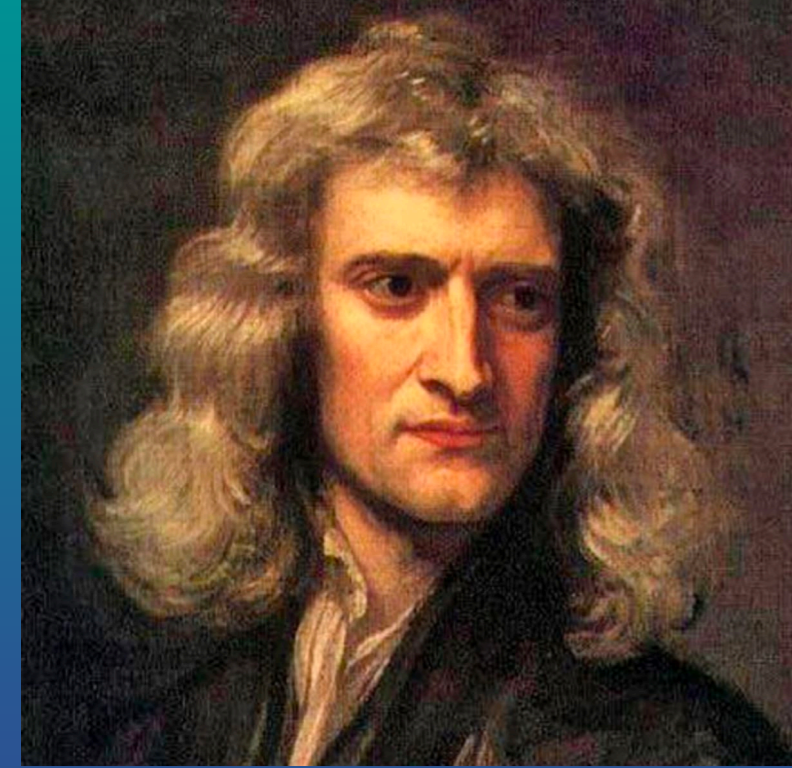

Newton



Laplace

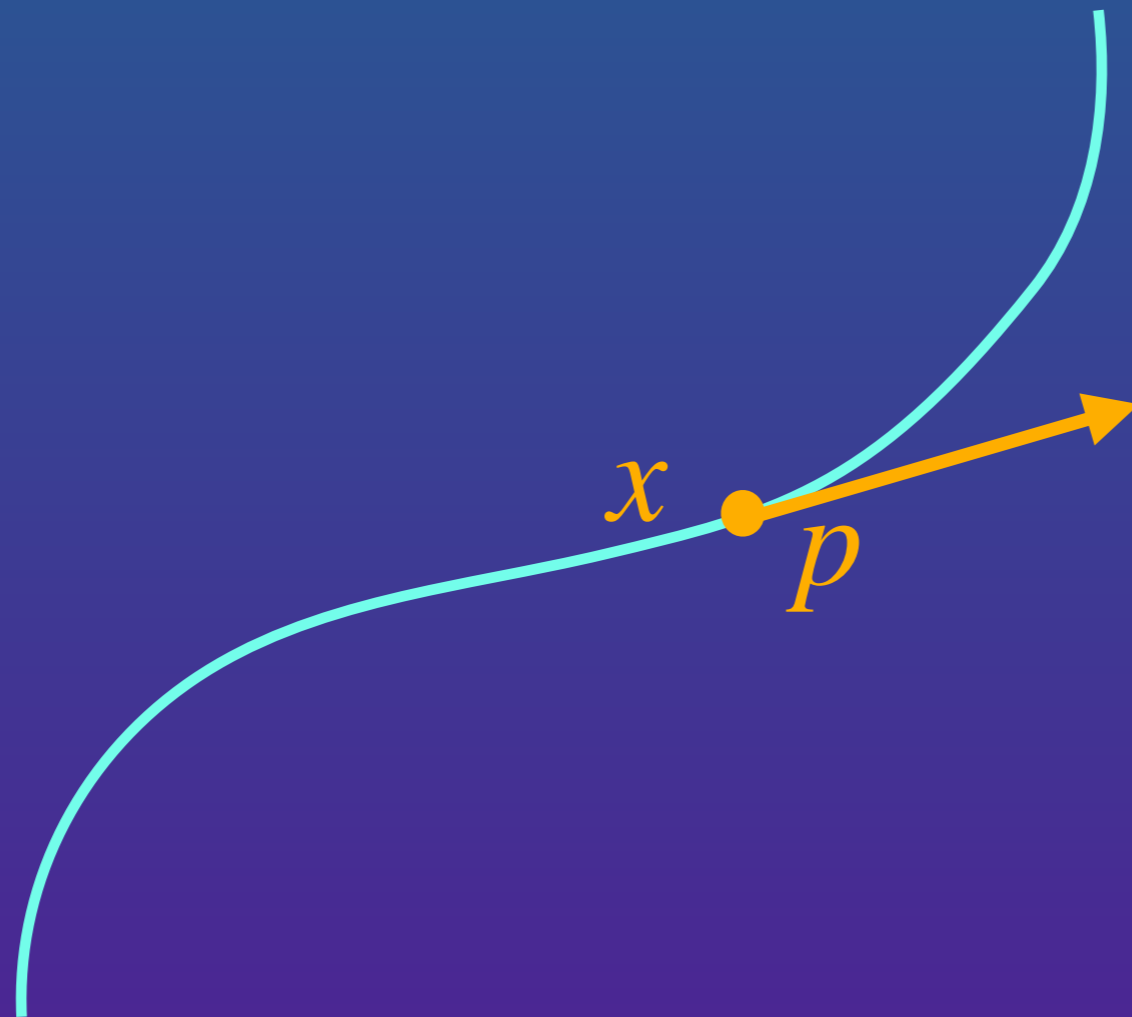

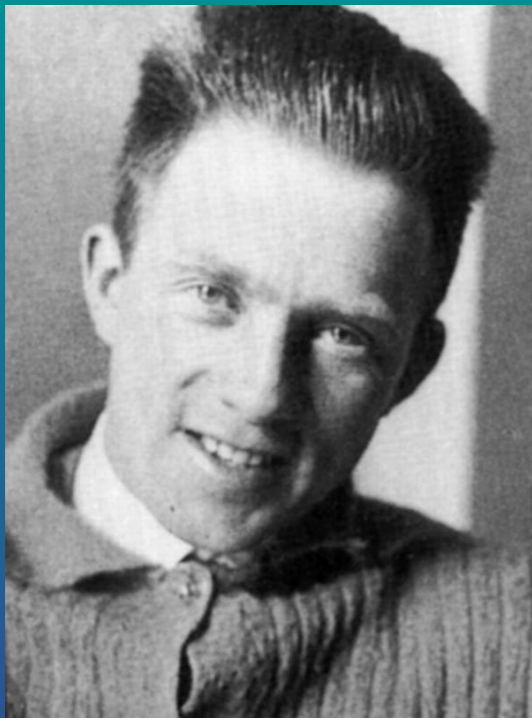

Heisenberg



Dirac



Schrodinger



Bhor

$\psi(x)$

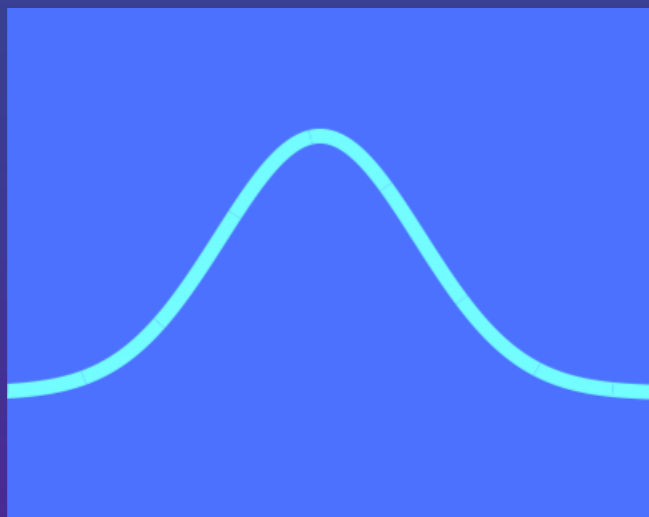

$\psi(p)$

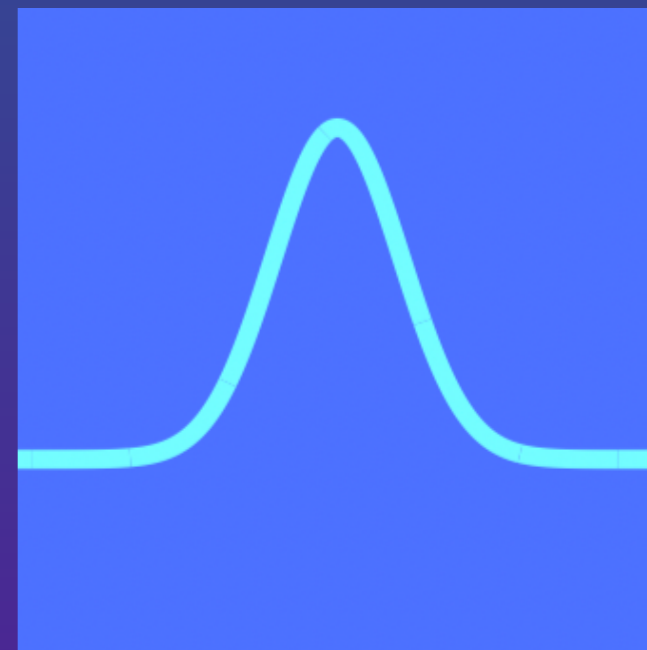

دیدگاه اول- مکان و سرعت ذره هر دو واقعیت دارند،

ولی ما نمی توانیم آنها را همزمان تعیین کنیم چون هر گاه یکی را می خواهیم تعیین کنیم، مشاهده ما مقدار دیگری را مختل می کند.

دیدگاه دوم- مکان و سرعت ذره هر دو با هم واقعیت ندارند، فقط چیزهایی واقعیت دارند که بتوانید آنها را مشاهده کنید.

دیدگاه یک:

تعیین رنگ توپ ها

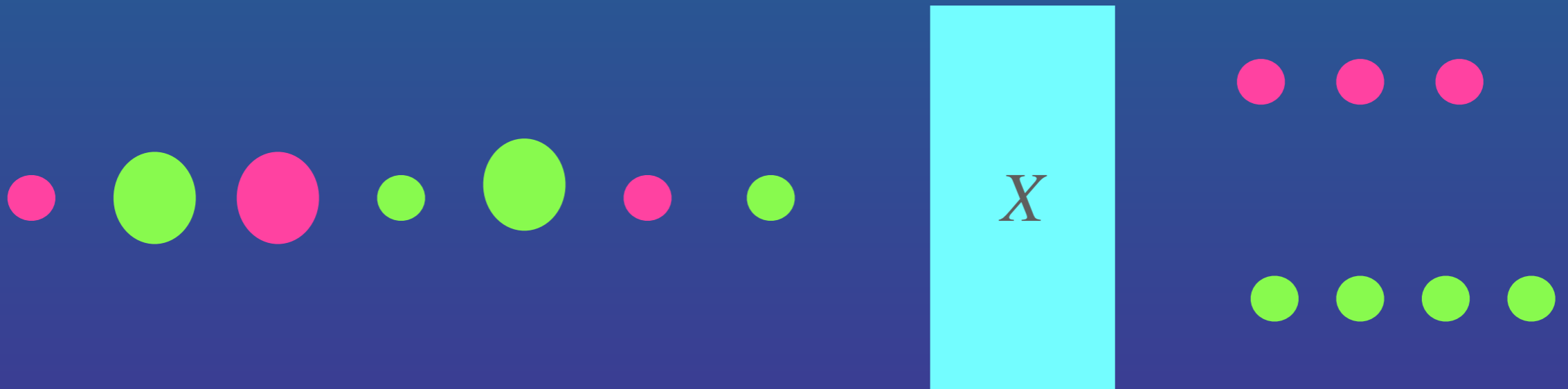

تعیین اندازه توپ ها

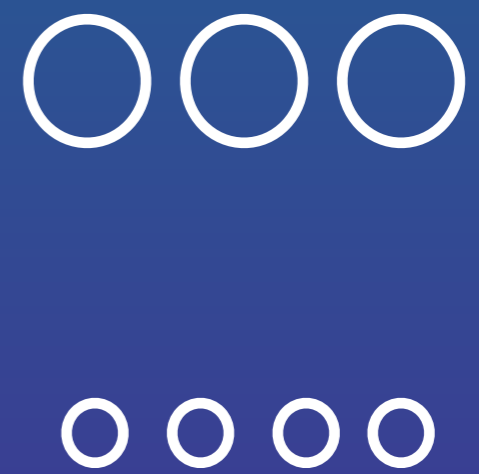

دیدگاه دوم:

این مشاهده است که خاصیت ها را به فعلیت می رساند و آنها را ظاهر می کند.

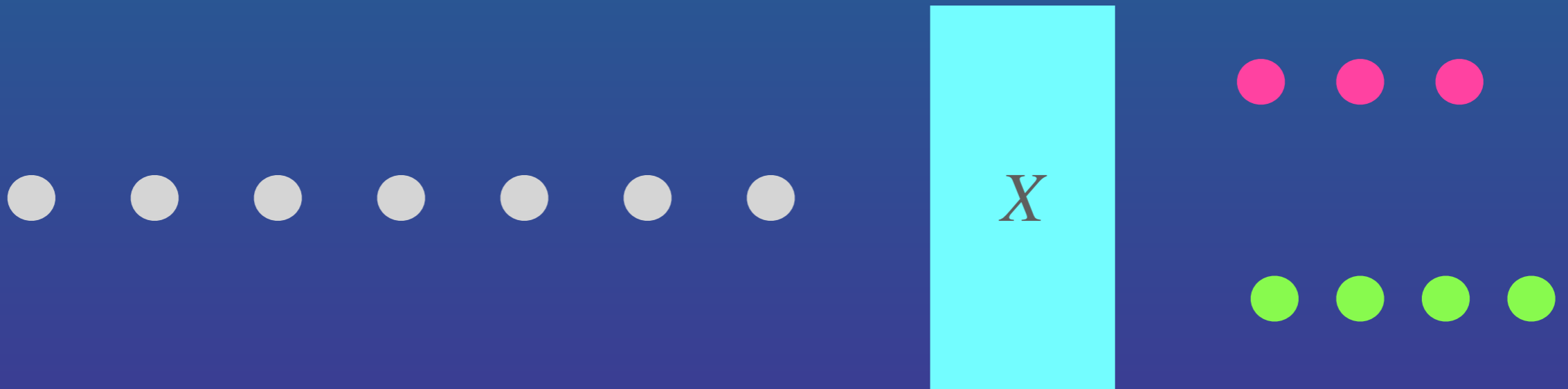



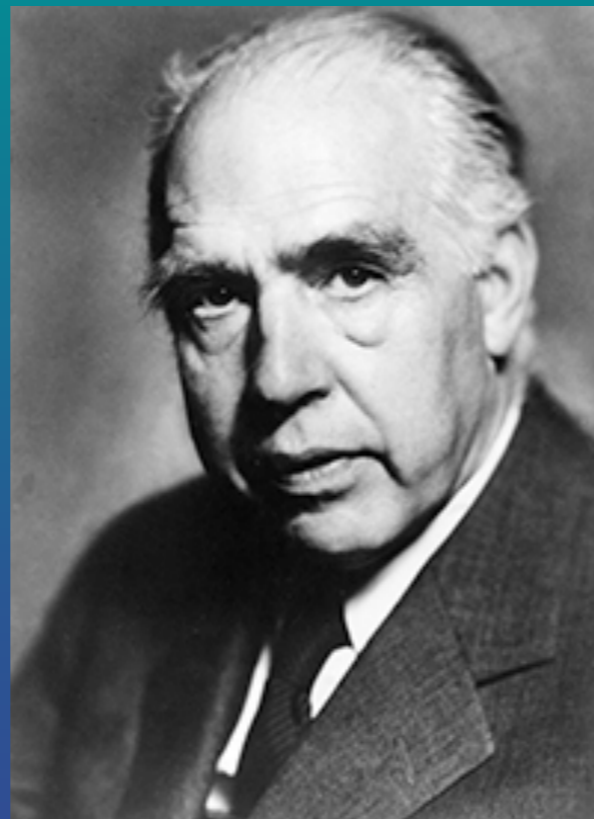

Complementarity

هر بار یک وجه از این واقعیت را می توانیم مشاهده کنیم.



Copenhagen View

Experimental Fact

توپ ها واقعا هم رنگ دارند و هم اندازه.
ولی ما نمی توانیم آنها را همزمان تعیین کنیم.

Interpretation

توپ ها قبل از مشاهده رنگ و اندازه واقعی ندارند.

مکانیک کوانتومی کامل ترین توصیف را
از حالت توپ ها ارائه می کند.

توصیف مکانیک کوانتومی کامل نیست،
چون به هر حال یک توپ در جهان خارج
از ذهن ما هم رنگ دارد و هم اندازه.





اگر هم توپ ها هم رنگ داشته باشند و هم اندازه
چون اندازه گیری ما از هر خصلت، خصلت دیگر را مختل
می کند، صحبت کردن از وجود همزمان آنها بی معنی است.

Observation → **Disturbance**

The EPR Argument (1935)

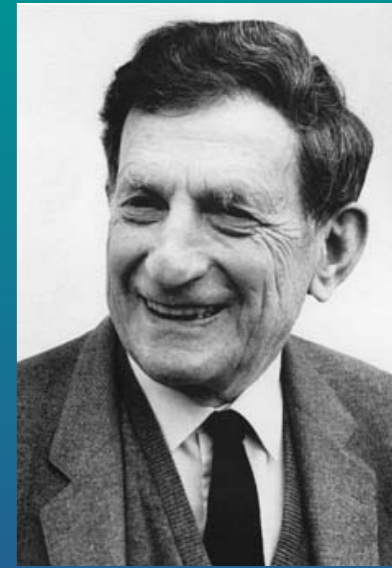
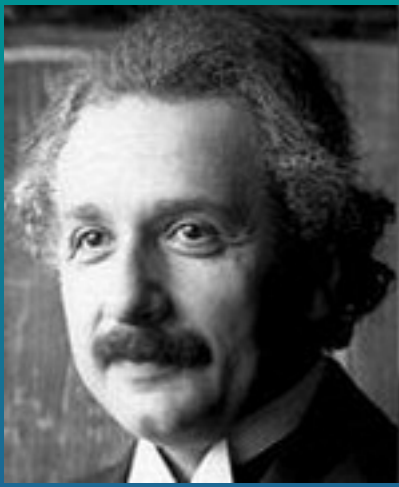

Einstein

Podolsky

Rosen

بسیار خوب، ما راهی را پیشنهاد می کنیم که بدون مختل کردن حالت یک توپ بتوانید هم رنگ و هم اندازه آن را تعیین کنید.

بنابراین مکانیک کوانتومی یک توصیف کامل از واقعیت جهان نیست.

$$|\psi^-\rangle = \frac{1}{\sqrt{2}}(|\uparrow, \downarrow\rangle - |\downarrow, \uparrow\rangle)$$

آلیس می تواند اسپین ذره خود را در جهت Z اندازه گیری کند و بدون تاثیر گذاری بر ذره باب، اسپین ذره باب را در همان جهت تعیین کند.

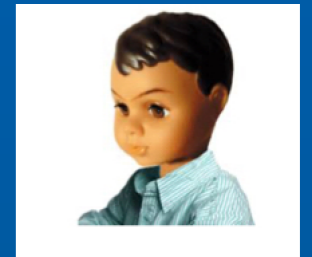
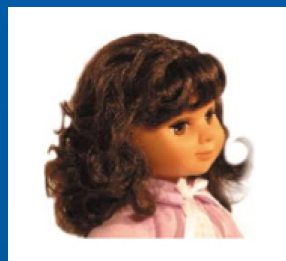



آلیس می تواند رنگ گوی خود را اندازه گیری کند
و بدون تاثیر گذاری بر گوی باب، رنگ آن را تعیین کند.

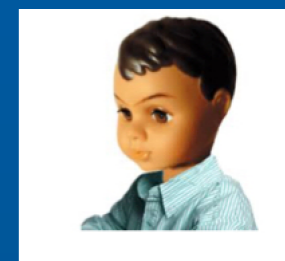
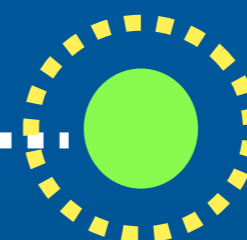
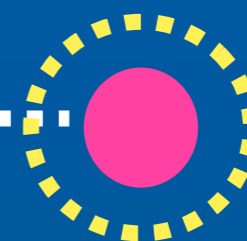
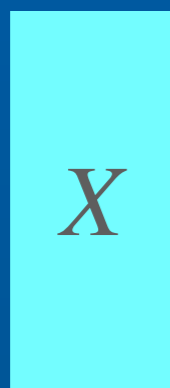

$$|\psi^-\rangle = \frac{1}{\sqrt{2}}(|\leftarrow, \rightarrow\rangle - |\rightarrow, \leftarrow\rangle)$$

آلیس می تواند اسپین ذره خود را در جهت X اندازه گیری کند و بدون تاثیر گذاری بر ذره باب، اسپین ذره باب را در همان جهت تعیین کند.



$$|\text{Large Circle Small Circle}\rangle - |\text{Small Circle Large Circle}\rangle$$

آلیس می تواند اندازه گوی خود را نیز اندازه گیری کند
و بدون تاثیر گذاری بر گوی باب، اندازه آن را نیز تعیین کند.

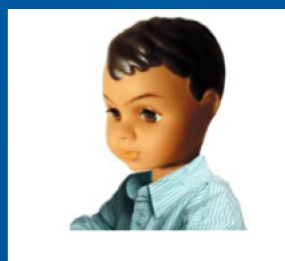
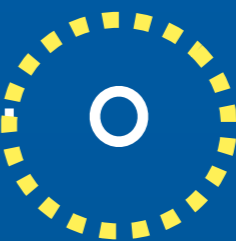

نتیجه؟

هم رنگ و هم اندازه واقعیت دارند.

مکانیک کوانتومی یک نظریه کامل در باره جهان واقعی نیست.

چگونه این پدیده را بفهمیم؟

متغیرهای پنهان.

$$|\text{green} \text{ red}\rangle - |\text{red} \text{ green}\rangle$$



Hidden Variables

$$|\text{green} \text{ red}\rangle$$

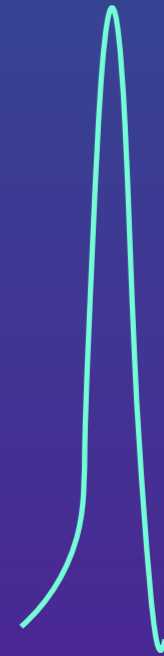

The speed of collapse $> 1000,000 c$



یک اشکال به EPR: ولی رنگ و اندازه برای یک توپ واحد تعیین نشده اند.
برای دو توپ مختلف تعیین شده اند.

پاسخ: علی الاصول می توانسته ایم بدون مختل کردن توپ،
رنگ یا اندازه آن را بنا بر خواست خود تعیین کنیم.

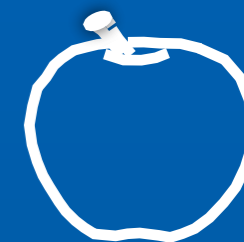

ولی بزرگی و سبزی برای یک سیب **واحد** تعیین نشده اند،
بلکه علی الاصول **می توانستند** تعیین شوند.

کل اندازه گیری ها یک آزمایش واحد و به هم وابسته است.



پاسخ بوهر؟!!

کل این آزمایش بین آلیس و باب می بایست به عنوان یک مشاهده در نظر گرفته شود.

What is real with respect to the second particle can depend in a nontrivial way on which measurement is performed on the first particle



چیدمان آزمایشگاهی آلیس روی ذره باب اثر می گذارد.
نوع اندازه گیری آلیس تعیین می کند که کدام خصلت توپی
که در دست باب است به فعلیت درآید.

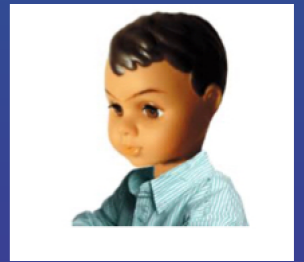

سفسطه و بی معنا.





John Bell

فرض ها: می پذیریم که:

1- که نتیجه مشاهده می تواند تصادفی باشد
(متغیر پنهان، مختل کردن، به فعلیت درآمدن...)

2- هیچ علامتی نمی تواند با سرعت بیشتر از نور حرکت کند.

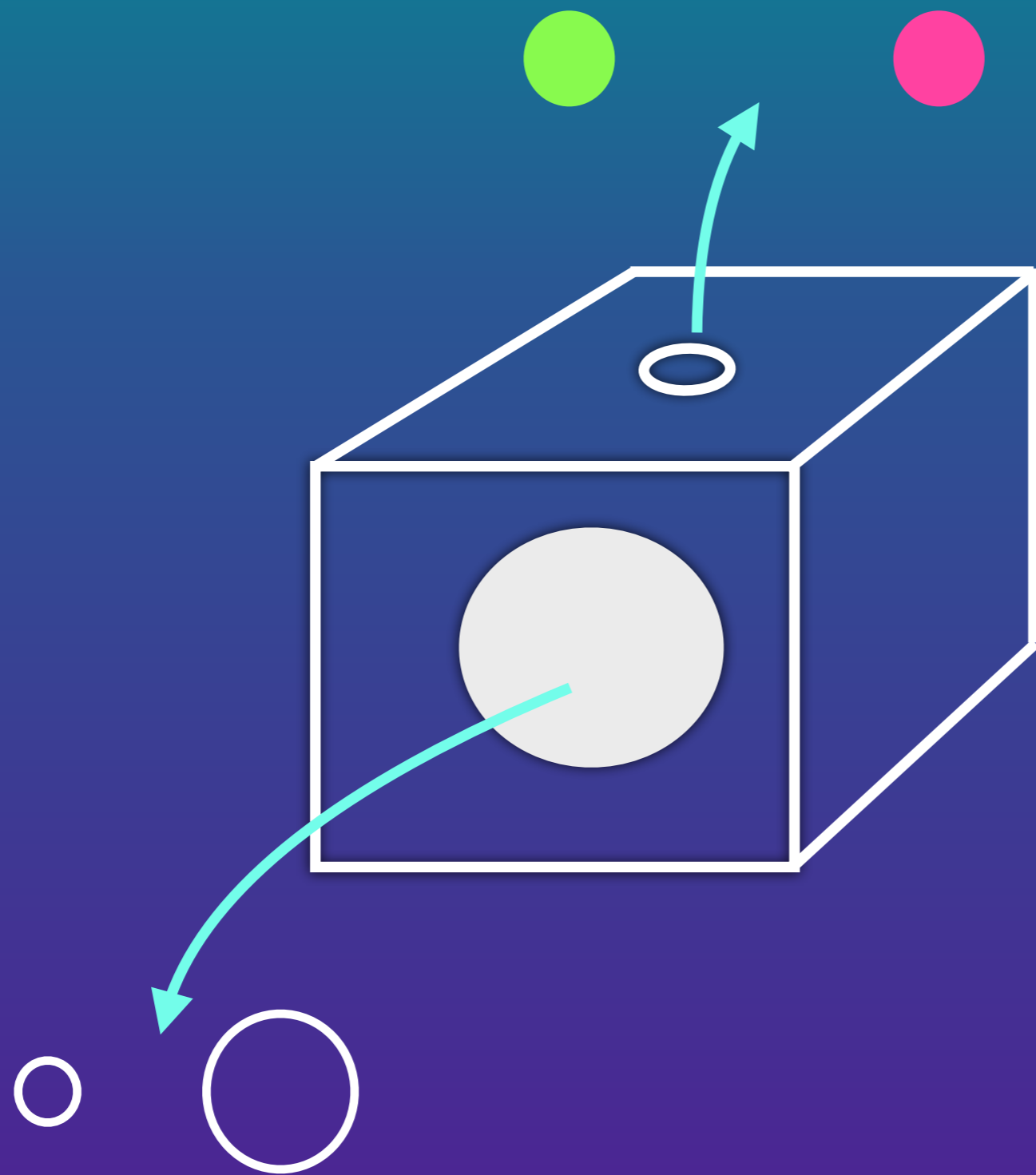

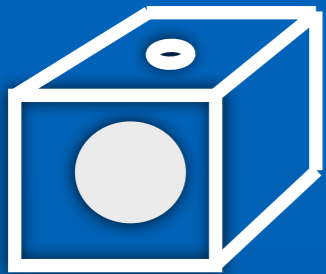

λ_1

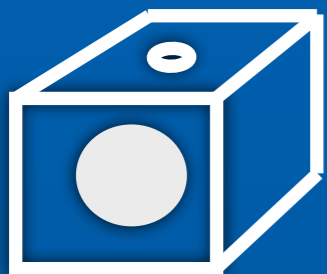
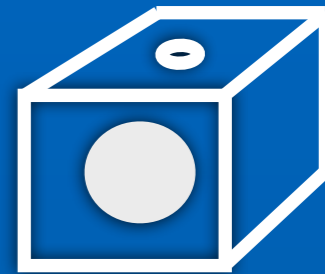

λ_2

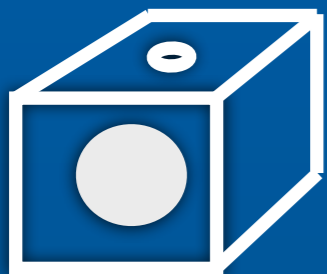
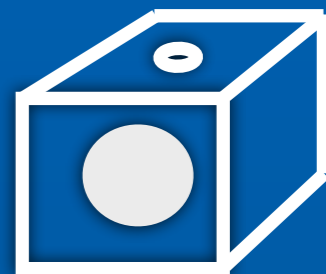

λ_3

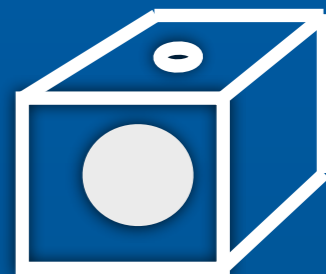

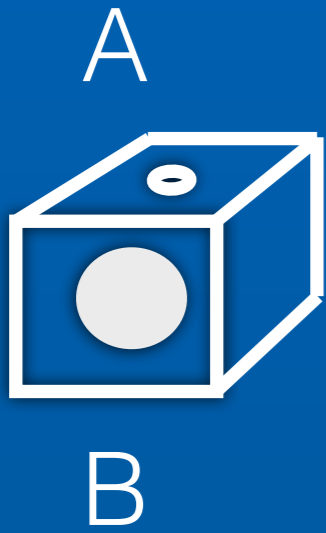

λ_1

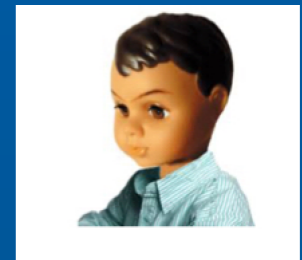
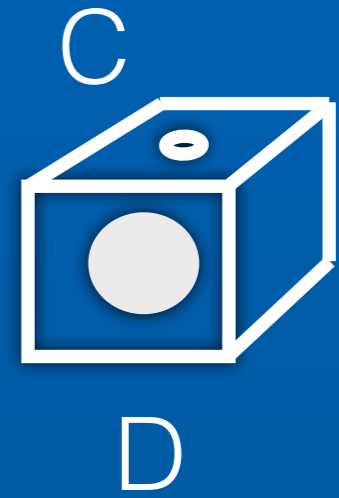

A

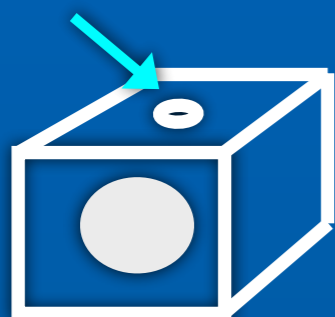

λ_1

C

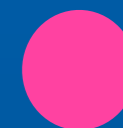
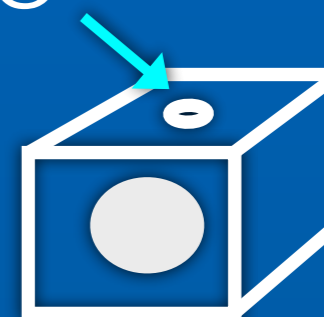

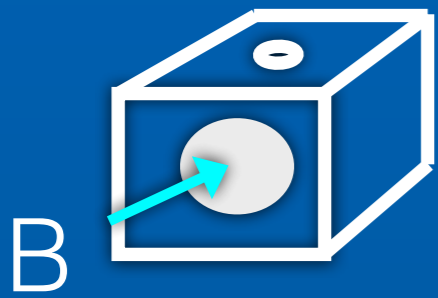

λ_1

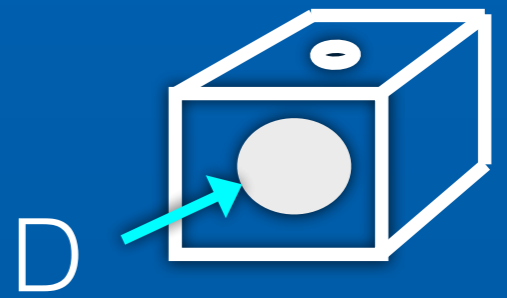

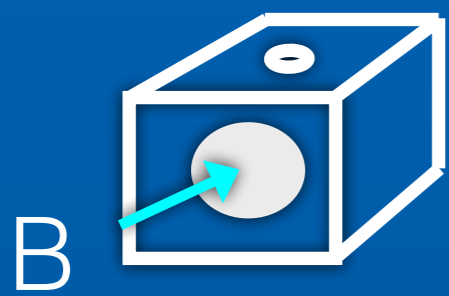

λ_1

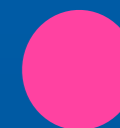
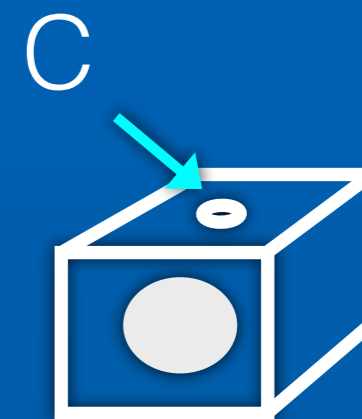

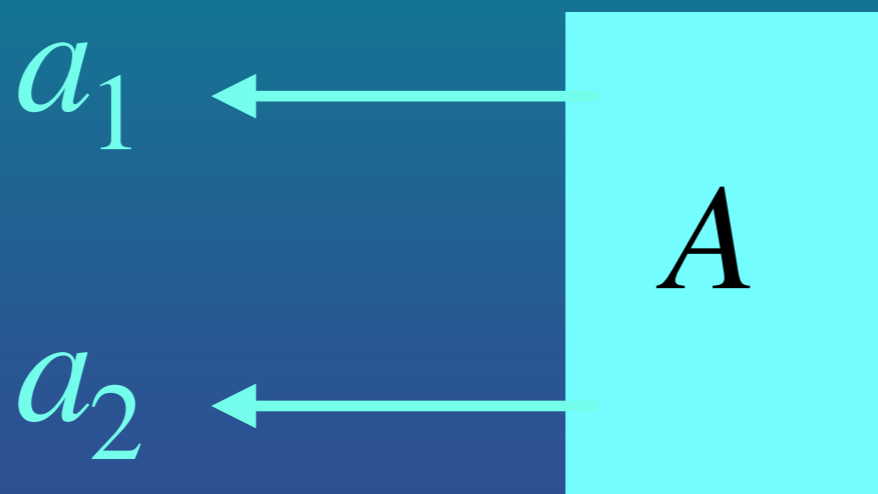

$P(a_1 | A, \lambda)$ احتمال اینکه اندازه گیری A مقدار a_1 را به فعلیت برساند.

$P(a_2 | A, \lambda)$ احتمال اینکه اندازه گیری A مقدار a_2 را به فعلیت برساند.

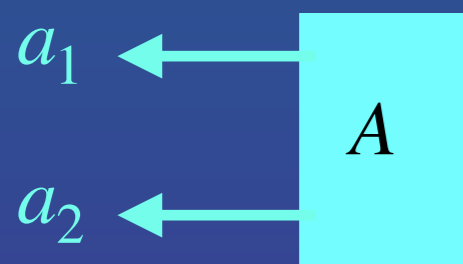

$$P(a, c | A, C, \lambda)$$

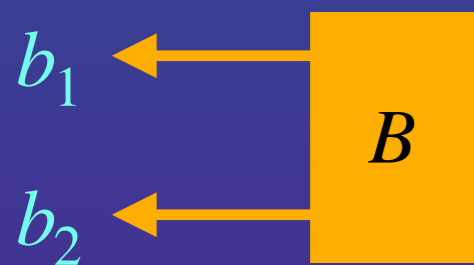
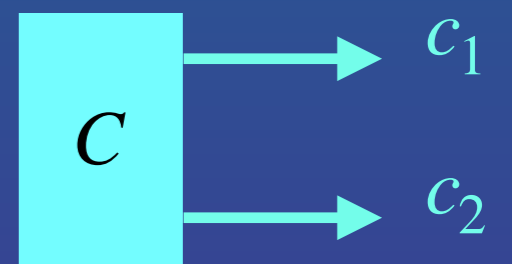

$$P(a, d | A, D, \lambda)$$

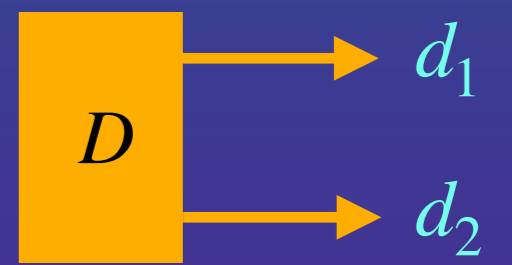

معنای موضوعیت

$$P(x, y | X, Y, \lambda) = P(x | X, \lambda)P(y | Y, \lambda)$$

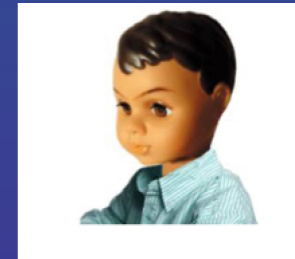
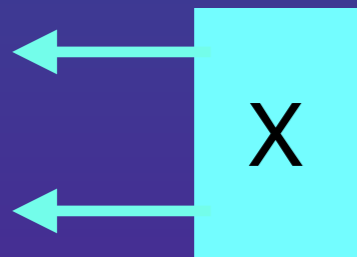

A	+1
B	+1
A	-1
A	+1
B	-1
A	-1
B	+1
B	-1

C	-1
D	+1
D	+1
C	-1
D	-1
C	+1
C	+1
D	-1

$$\langle AC \rangle = \sum_{i,j} a_i c_j P(a_i, c_j | A, C, \lambda)$$

$$\langle AC \rangle = \sum_{i,j} \int a_i c_j P(a_i, c_j | A, C, \lambda) P(\lambda) d\lambda$$

نامساوی بل

$$\left| \langle A(C + D) + B(C - D) \rangle \right| \leq 2$$

Bell

مهم ترین نکته: نامساوی بل ربطی به مکانیک کوانتومی ندارد.

بلکه گزاره ای است در باره موضعی بودن جهان.



John Clauser

I had great problems all my life
understanding the square root of minus one!

We define a particle as being something for which
this operator commutes with that operator, etc.
I haven't the foggiest idea what any of that means.

آزمایش (۱۹۷۰)



What a pointless waste of time?

Oral History Interviews, American Institute of Physics (2002)

نتیجه آزمایش

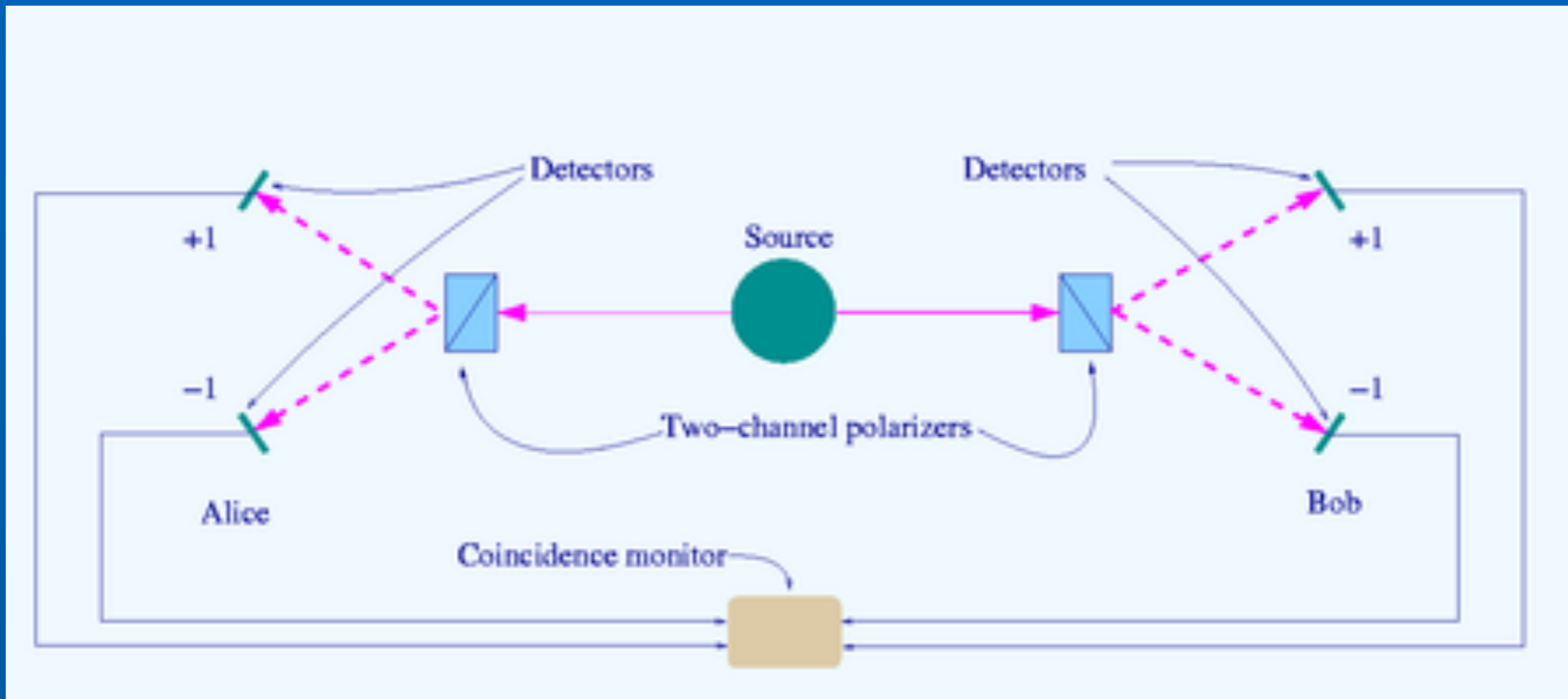

$Bell < 2$

هاروارد

$Bell > 2$

برکلی

اشکالات آزمایش کلاوزر:

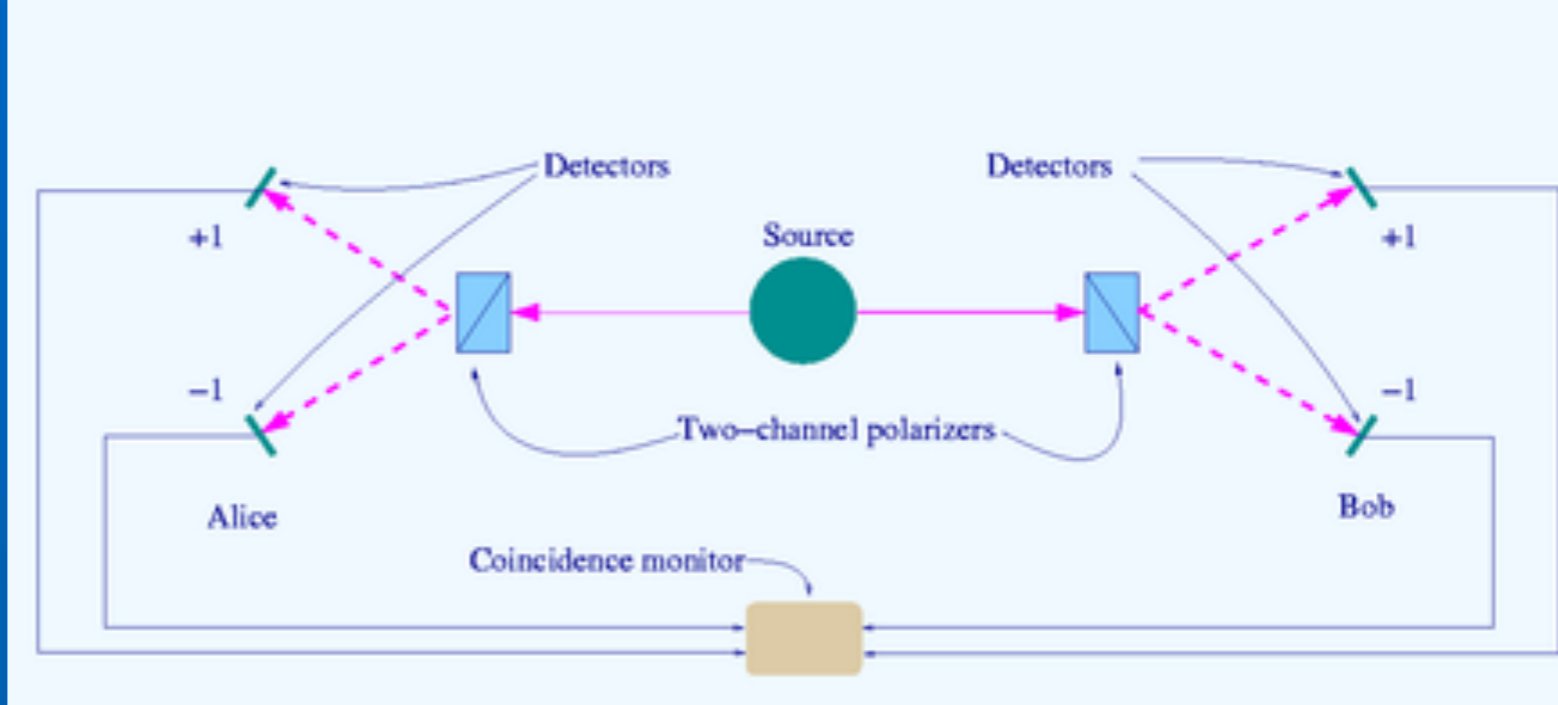

یک - چشمه فوتونی ضعیف - طول زمان آزمایش یک هفته

دو- اثر پلاریزورها بر یک دیگر

سه - اثر پلاریزورها بر فوتون های ساطع شده

198.



Alan Aspect

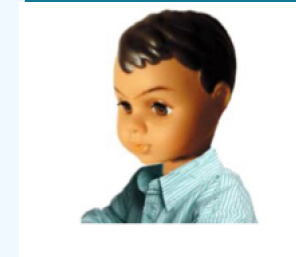
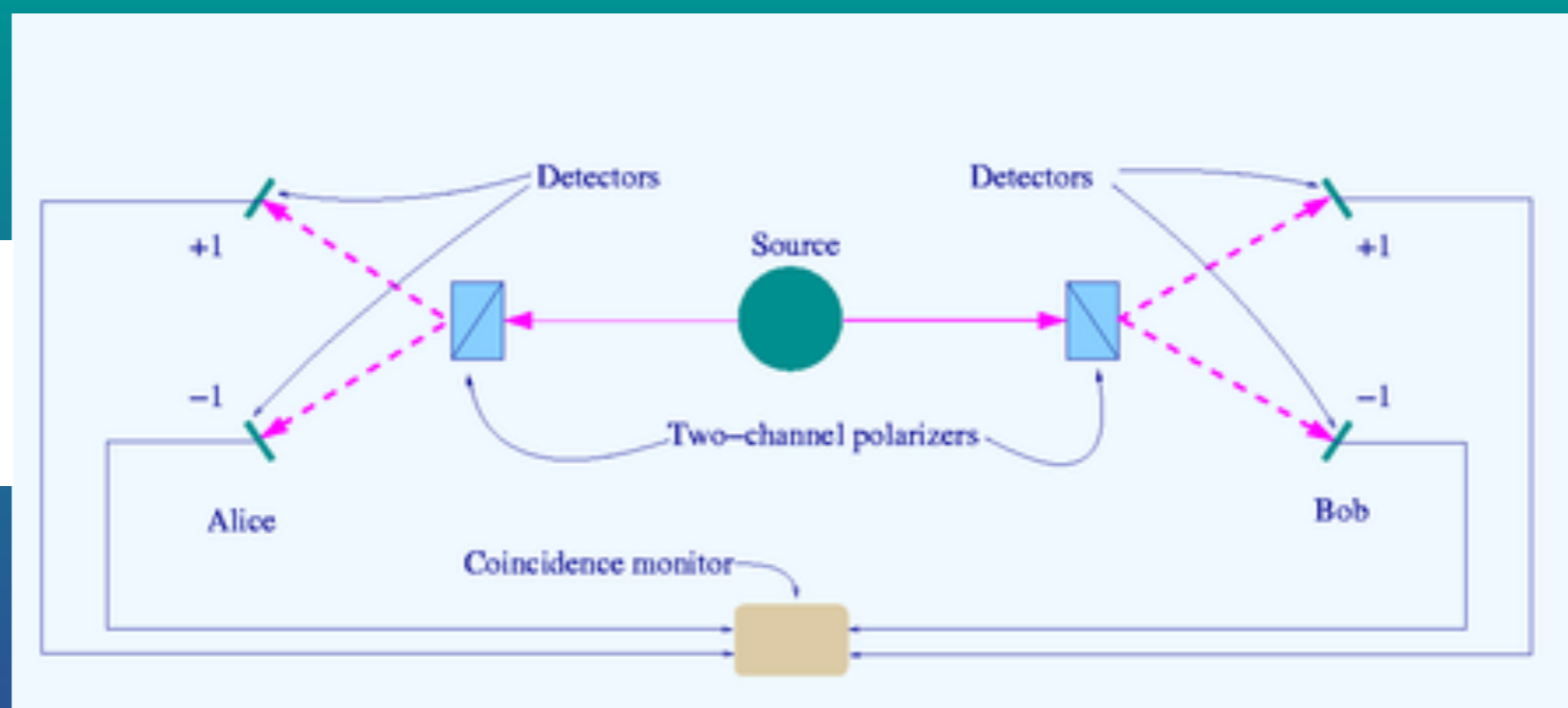

12 m

$$Bell = 2\sqrt{2}$$

یک - چشمه فوتونی قوی - طول زمان آزمایش ۱۰۰ ثانیه

دو- هر پلاریزور به طور مستقل و تصادفی تنظیم می شود.

سه - جهت پلاریزورها در زمان پرواز فوتون ها تنظیم می شود.

Free Will Loophole

از کجا معلوم که ایس و باب واقعا با اراده آزاد و مستقل از هم جهت قطبش گرهارا تنظیم می کنند.

$$P(x, y|X, Y, \lambda) \neq P(x|X, \lambda)P(y|Y, \lambda)$$

The Big Bell Test (30 November 2016)

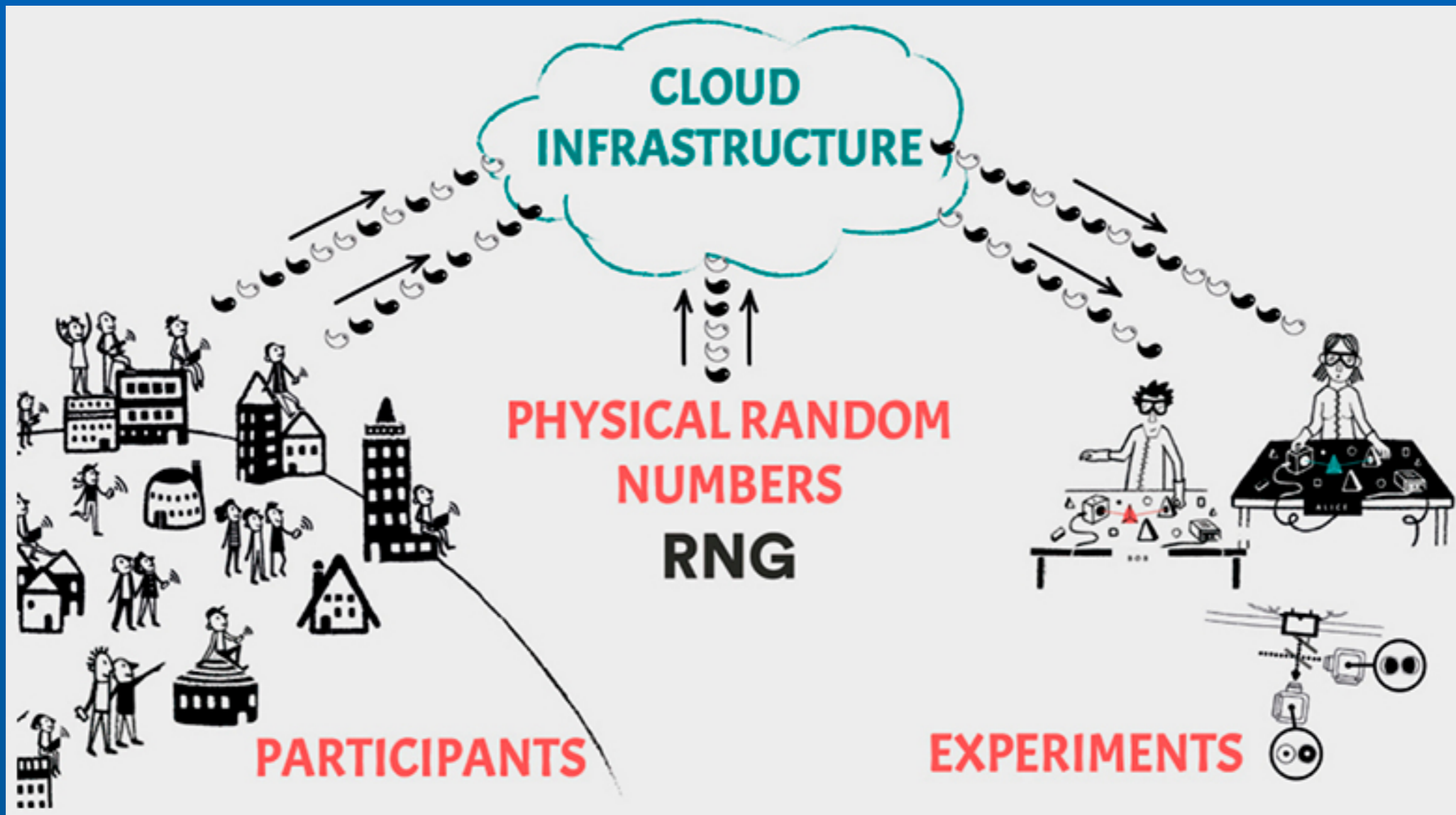

100,000 participants
12 hours, 1000 bits / seconds

Free Will Loophole

از کجا معلوم که این صدهزار نفر با اراده واقعا آزاد و مستقل از هم جهت قطبش گرهارا تنظیم می کنند.

$$P(x, y|X, Y, \lambda) \neq P(x|X, \lambda)P(y|Y, \lambda)$$

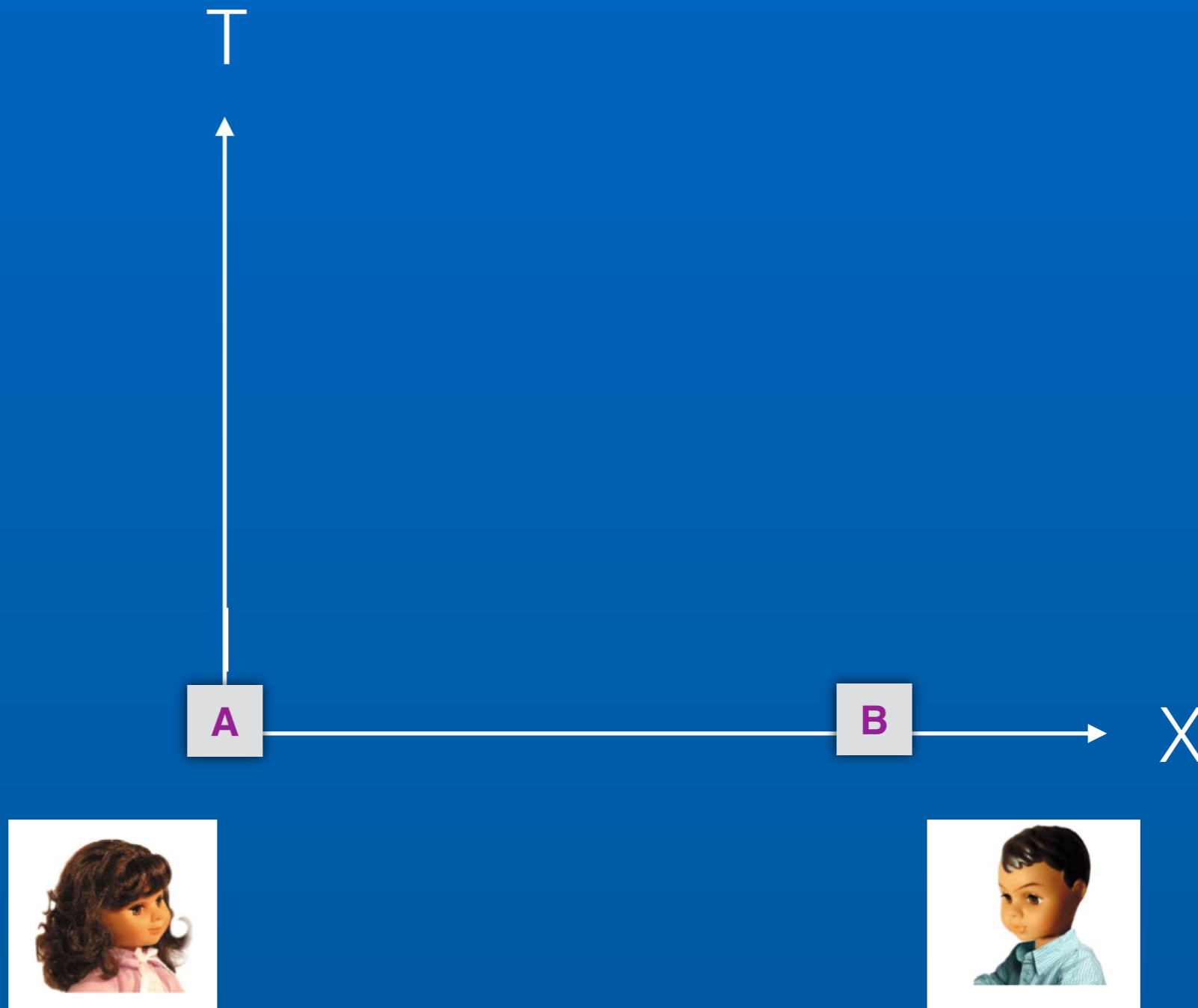

بجای اراده انسانی یک فرایند اتمی و تصادفی جهت قطبش گر ها را تنظیم کند.

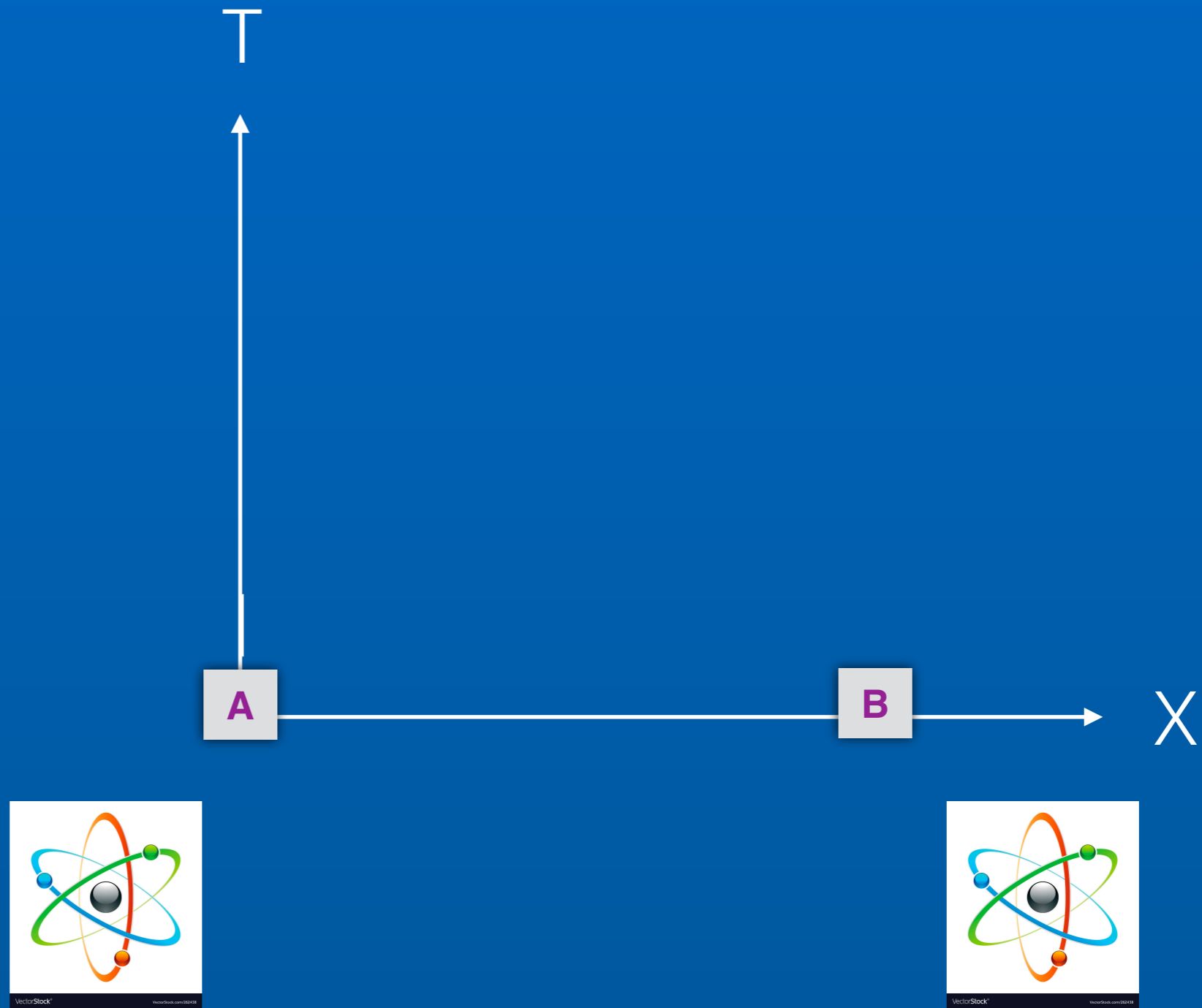

از کجا معلوم که خود این اتم ها قبلا با هم همبسته نشده اند.

شعاع نور

T

A

B

X

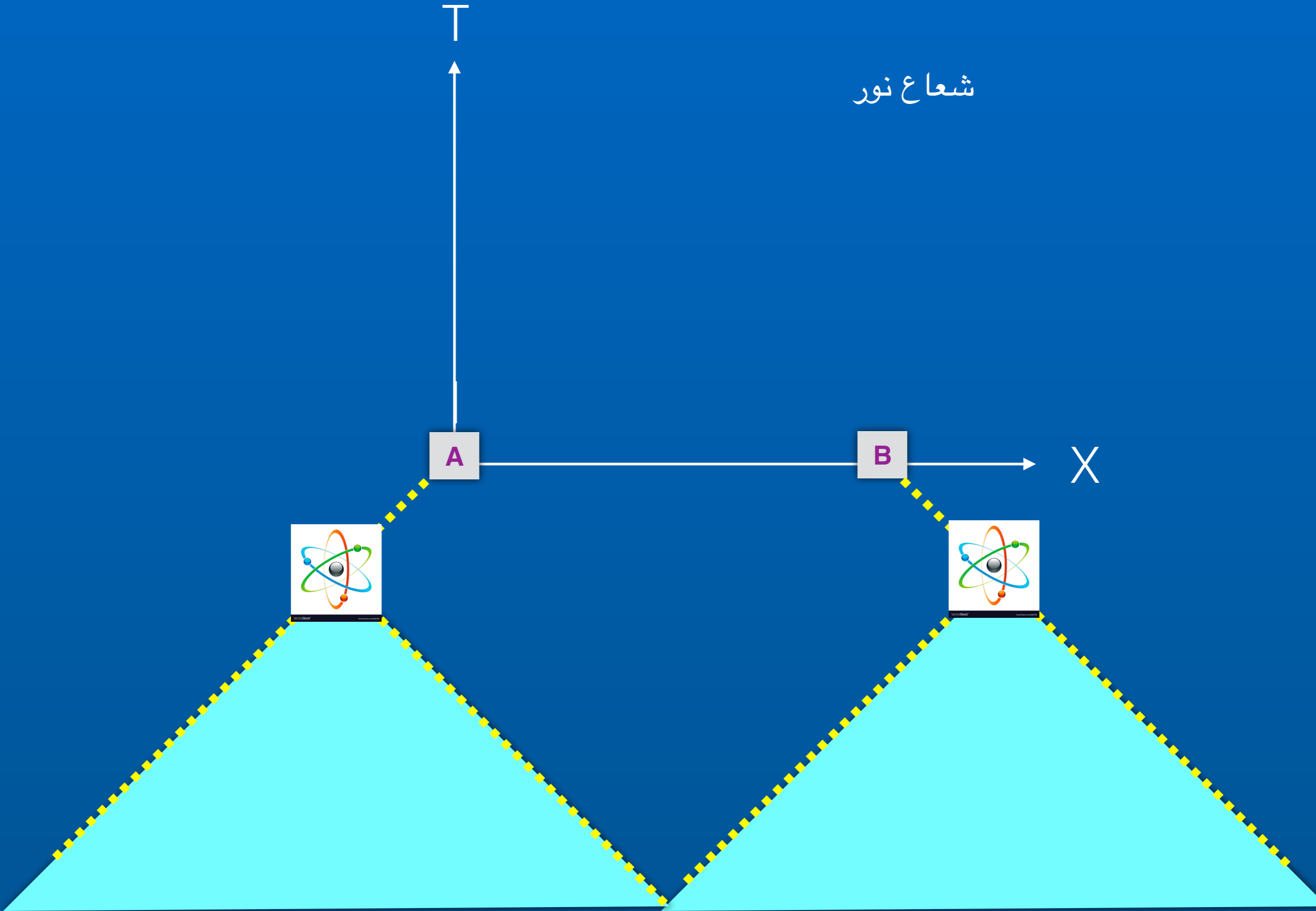

COSMIC BELL TEAM



**Prof. David
Kaiser** ^{1,2}



**Dr. Andrew
Friedman** ^{1,2}



**Prof. Alan
Guth** ¹



**Prof. Brian
Keating** ⁴



**Prof. Anton
Zeilinger** ⁵



**Dr. Jason
Gallicchio** ³

Other Collaborators

Dr. Hien Nguyen ⁷,
Dr. Thomas Scheidl ⁵,
Dr. Johannes Kofler ⁶,
Johannes Handsteiner ⁵,
Marissa Giustina ⁵

Isabella Sanders ¹,
Anthony Mark ¹



1:MIT Physics/CTP, 2:MIT STS, 3:U. Chicago
KICP / Harvey Mudd, 4: UCSD, 5: Vienna IQOQI,
6: Max Planck, 7: JPL/Caltech

MIT News

ON CAMPUS AND AROUND THE WORLD

Browse

or

Search



FULL SCREEN

Artist's interpretation of ULAS J1120+0641, a very distant quasar.

Image: ESO/M. Kornmesser

Closing the 'free will' loophole

MIT researchers propose using distant quasars to test Bell's theorem.

Jennifer Chu, MIT News Office
February 20, 2014

Press Inquiries



PRESS MENTIONS

In a paper published this week in the journal *Physical Review Letters*, MIT researchers



PHYSICAL REVIEW LETTERS

[Highlights](#)
[Recent](#)
[Accepted](#)
[Collections](#)
[Authors](#)
[Referees](#)
[Search](#)
[Press](#)
[About](#)

Featured in Physics

Editors' Suggestion

Open Access

Cosmic Bell Test: Measurement Settings from Milky Way Stars

Johannes Handsteiner, Andrew S. Friedman, Dominik Rauch, Jason Gallicchio, Bo Liu, Hannes Hosp, Johannes Kofler, David Bricher, Matthias Fink, Calvin Leung, Anthony Mark, Hien T. Nguyen, Isabella Sanders, Fabian Steinlechner, Rupert Ursin, Sören Wengerowsky, Alan H. Guth, David I. Kaiser, Thomas Scheidl, and Anton Zeilinger

Phys. Rev. Lett. **118**, 060401 – Published 7 February 2017

See Synopsis: [Cosmic Test of Quantum Mechanics](#)



Article

PDF

HTML

Export Citation



ABSTRACT

Bell's theorem states that some predictions of quantum mechanics cannot be reproduced by a local-realist theory. That conflict is expressed by Bell's inequality, which is usually derived under the assumption that there are no statistical correlations between the choices of measurement settings and anything else that can causally affect the measurement outcomes. In previous experiments, this "freedom of choice" was addressed by ensuring that selection of measurement settings via conventional "quantum random number generators" was spacelike separated from the entangled particle creation. This, however, left open the possibility that an unknown cause affected both the

Issue

Vol. 118, Iss. 6 — 10 February 2017

Reuse & Permissions

Editors' Suggestion

Open Access

Cosmic Bell Test Using Random Measurement Settings from High-Redshift Quasars

Dominik Rauch, Johannes Handsteiner, Armin Hochrainer, Jason Gallicchio, Andrew S. Friedman, Calvin Leung, Bo Liu, Lukas Bulla, Sebastian Ecker, Fabian Steinlechner, Rupert Ursin, Beili Hu, David Leon, Chris Benn, Adriano Ghedina, Massimo Cecconi, Alan H. Guth, David I. Kaiser, Thomas Scheidl, and Anton Zeilinger
 Phys. Rev. Lett. **121**, 080403 – Published 20 August 2018



Article

References

No Citing Articles

Supplemental Material

PDF

HTML

Export Citation



ABSTRACT

In this Letter, we present a cosmic Bell experiment with polarization-entangled photons, in which measurement settings were determined based on real-time measurements of the wavelength of photons from high-redshift quasars, whose light was emitted billions of years ago; the experiment simultaneously ensures locality. Assuming fair sampling for all detected photons and that the wavelength of the quasar photons had not been selectively altered or previewed between emission and detection, we observe statistically significant violation of Bell's inequality by 9.3 standard deviations, corresponding to an estimated p value of $\lesssim 7.4 \times 10^{-21}$. This experiment pushes back to at least ~ 7.8 Gyr ago the most recent time by which any local-realist influences could have exploited the “freedom-of-choice” loophole to engineer the observed Bell violation, excluding any such mechanism from 96% of the space-time volume of the past light cone of our experiment, extending from the big bang to today.

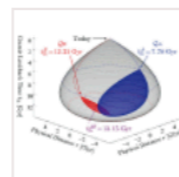
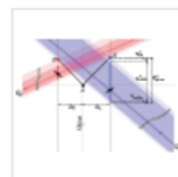

Revised 14 June 2018

Received 5 April 2018

Issue

Vol. 121, Iss. 8 – 24 August 2018



Reuse & Permissions

PHYSICAL
REVIEW
JOURNALS

125
YEARS

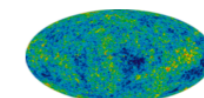

1981: Guth
proposes

Cosmic Bell Test

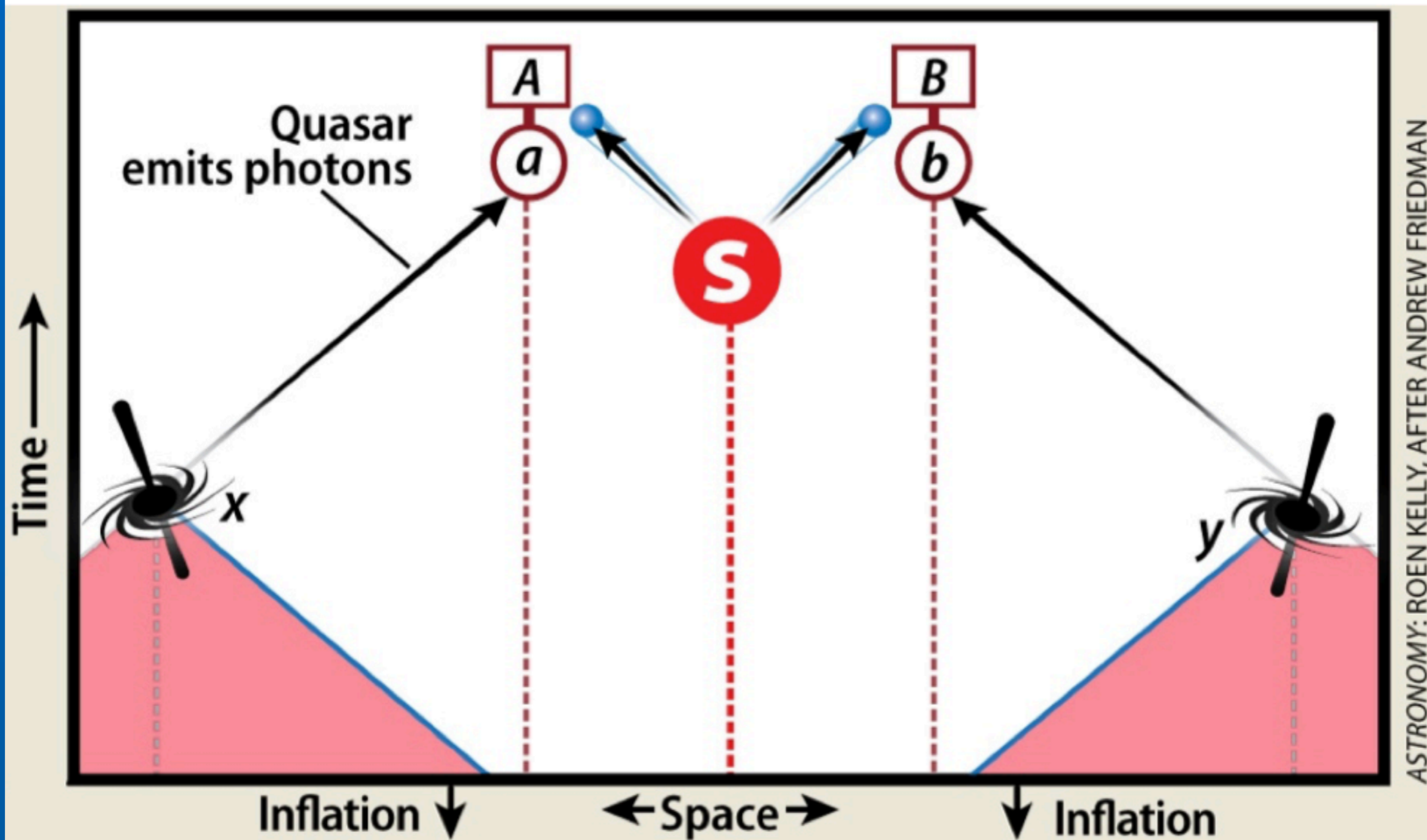

Past light cones from quasars don't overlap since big bang, 13.8 billion years ago.

Experiments

Freedman and Clauser	The first experiment	1972
Aspect et al.	Switching	1982
Tittel et al	Several Km's	
Weih's et al.	Using Real Randomness	1998
Pan et al.	GHZ	2000
Go et al.	In B mesons	2001
Salart et al.	18 Km's	2008
The BIG Bell Test	100,000 people	2018
Rauch et al	Cosmic Bell Test	2018

کمی تبلیغ و کمی تارخ (مربوط به ۱۰۰ سال قبل)





Home

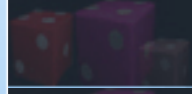

People

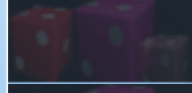

Publications



Seminars

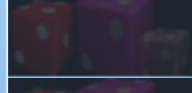

Visitors

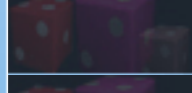

Events

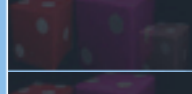

Links



Photos

Quantum Information Science @ Sharif University of Technology

Our group at the Department of Physics of Sharif University of Technology (Tehran, Iran) focuses on basic research on quantum information science and quantum computation. Specifically, some of the topics our members are currently working on are:

- Matrix-Product States
- Quantum Phase Transitions
- Measurement-based Quantum Computation
- Adiabatic Quantum Computation
- Topological Quantum Computation
- Quantum Channels
- Identification/Tomography of Quantum States and Dynamics
- Control of Open Quantum Systems
- Quantum Correlations
- Quantum Metrology/Estimation
- Thermodynamics of Open Quantum Systems

News:

- Professor [Anton Zeilinger](#), a world-leading physicist from the University of Vienna and Vienna University of Technology, and the President of the Austrian Academy of Sciences, will visit our group on May 4, 2014.

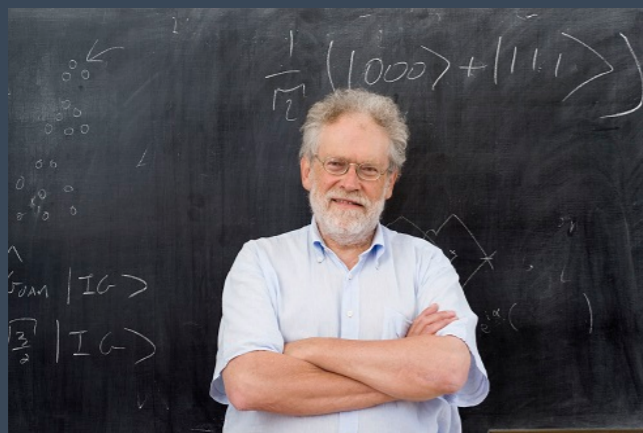



با تشکر از توجه شما

$$P(x|X) = |\langle x|\psi\rangle|^2$$

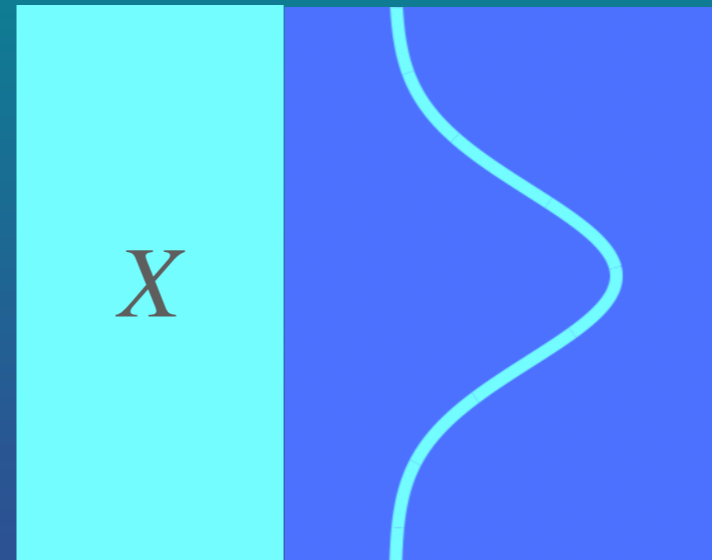

$$P(y|Y) = |\langle y|\psi\rangle|^2$$



Clauser-Horne-Shimony-Holt

$$(X, \lambda) \longrightarrow x$$



$$P(x | X, \lambda)$$

